

Connect the dots! Count by 1's.

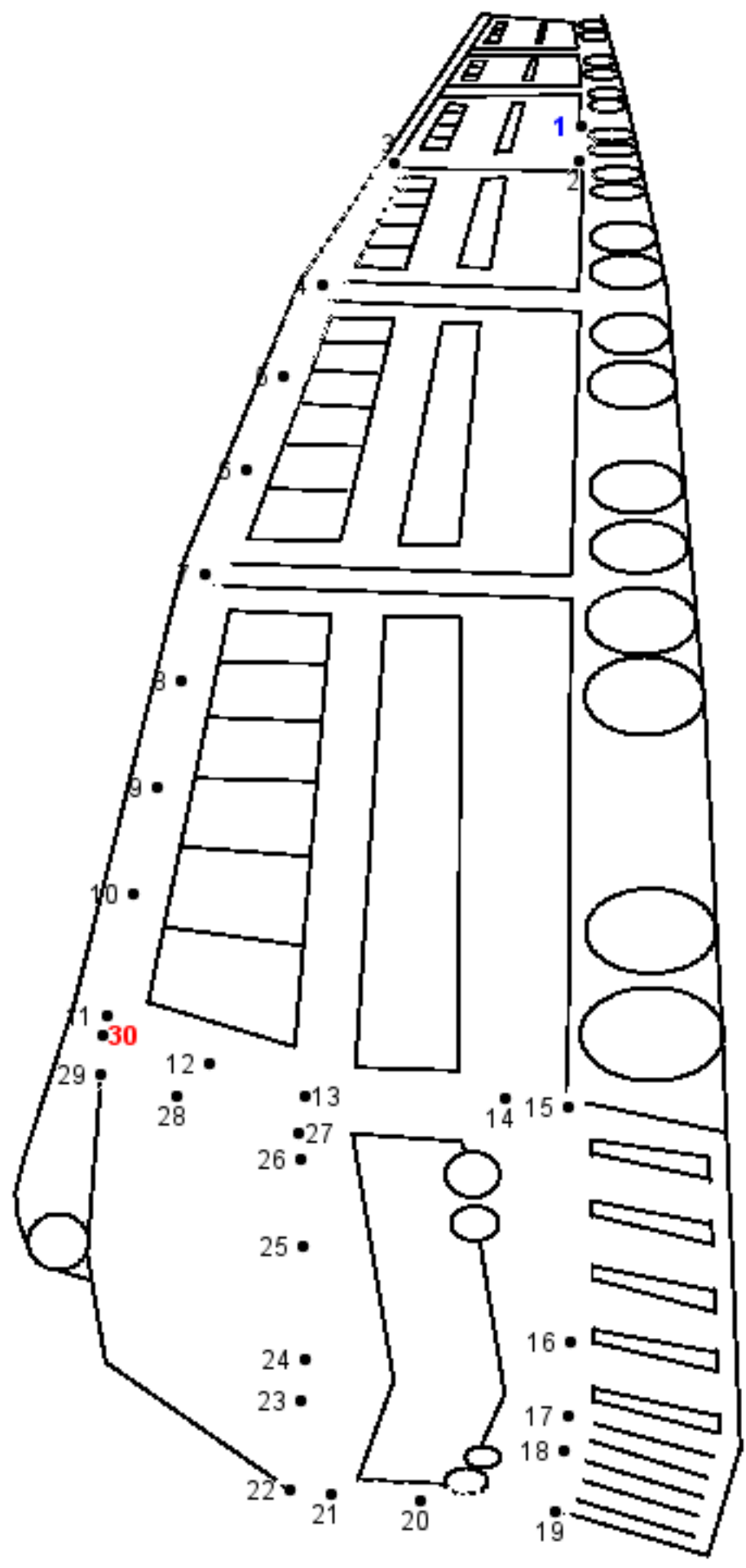

Connect the dots! Count by 1's.

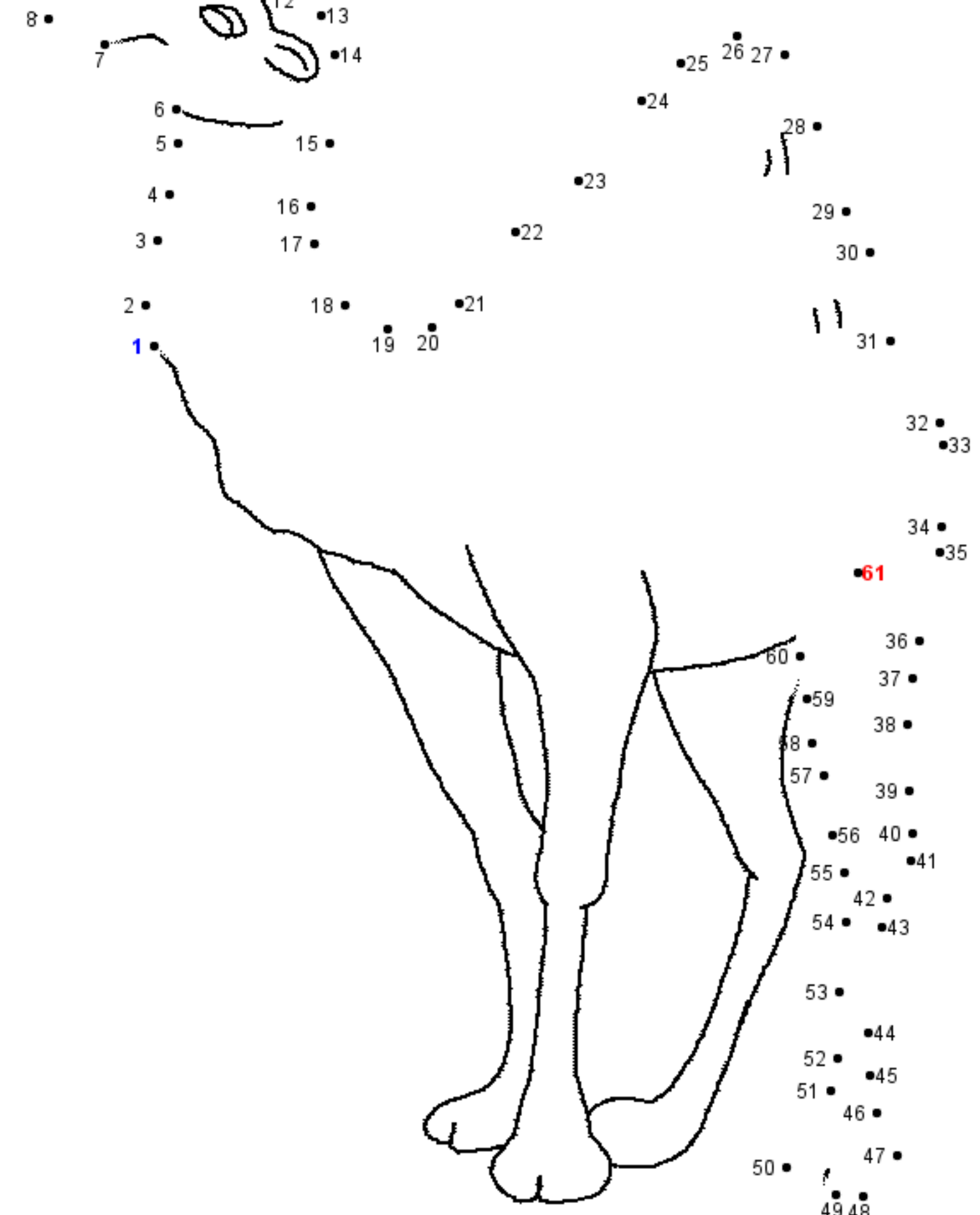

Connect the dots! Count by 1's.

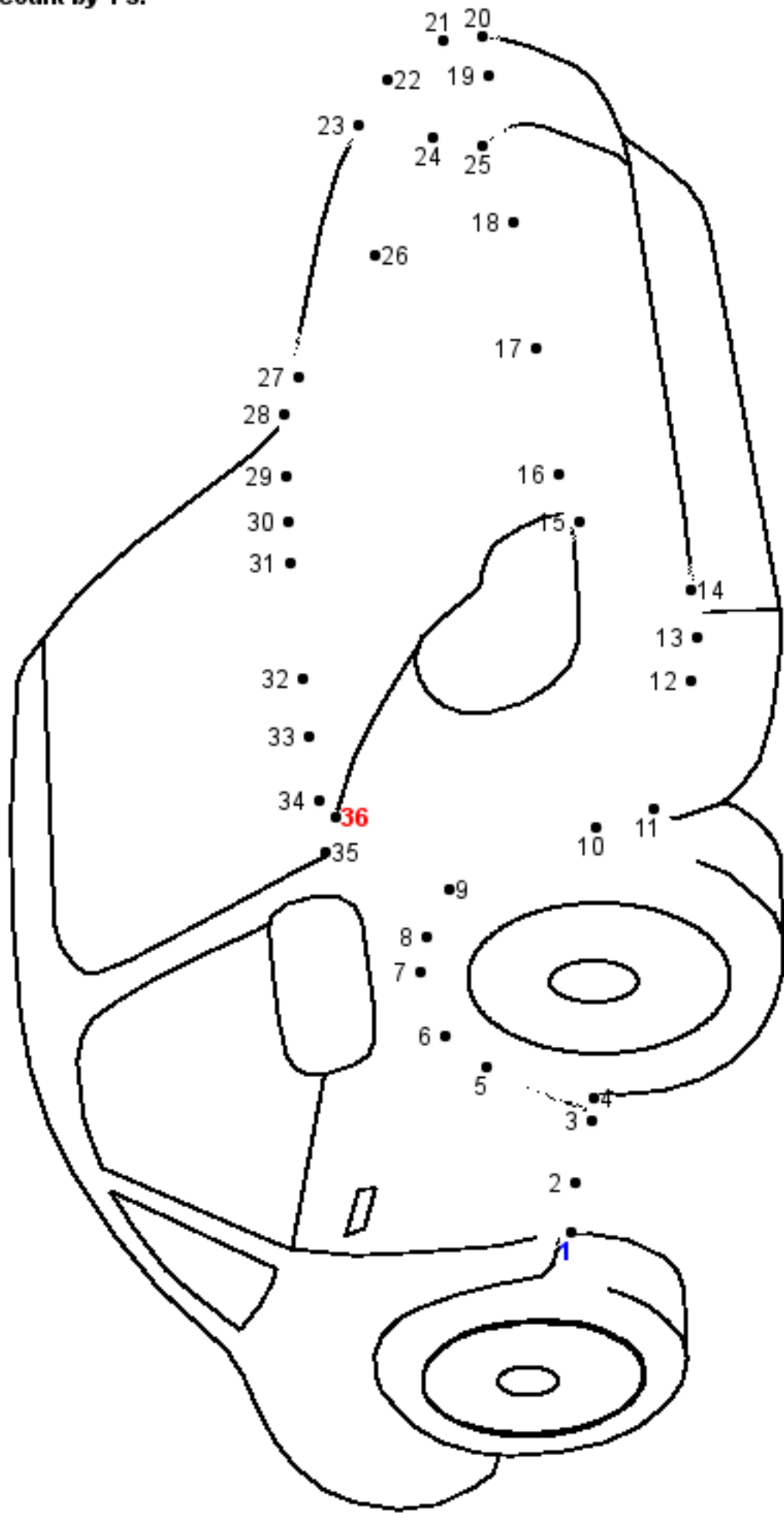

Connect the dots! Count by 1's.

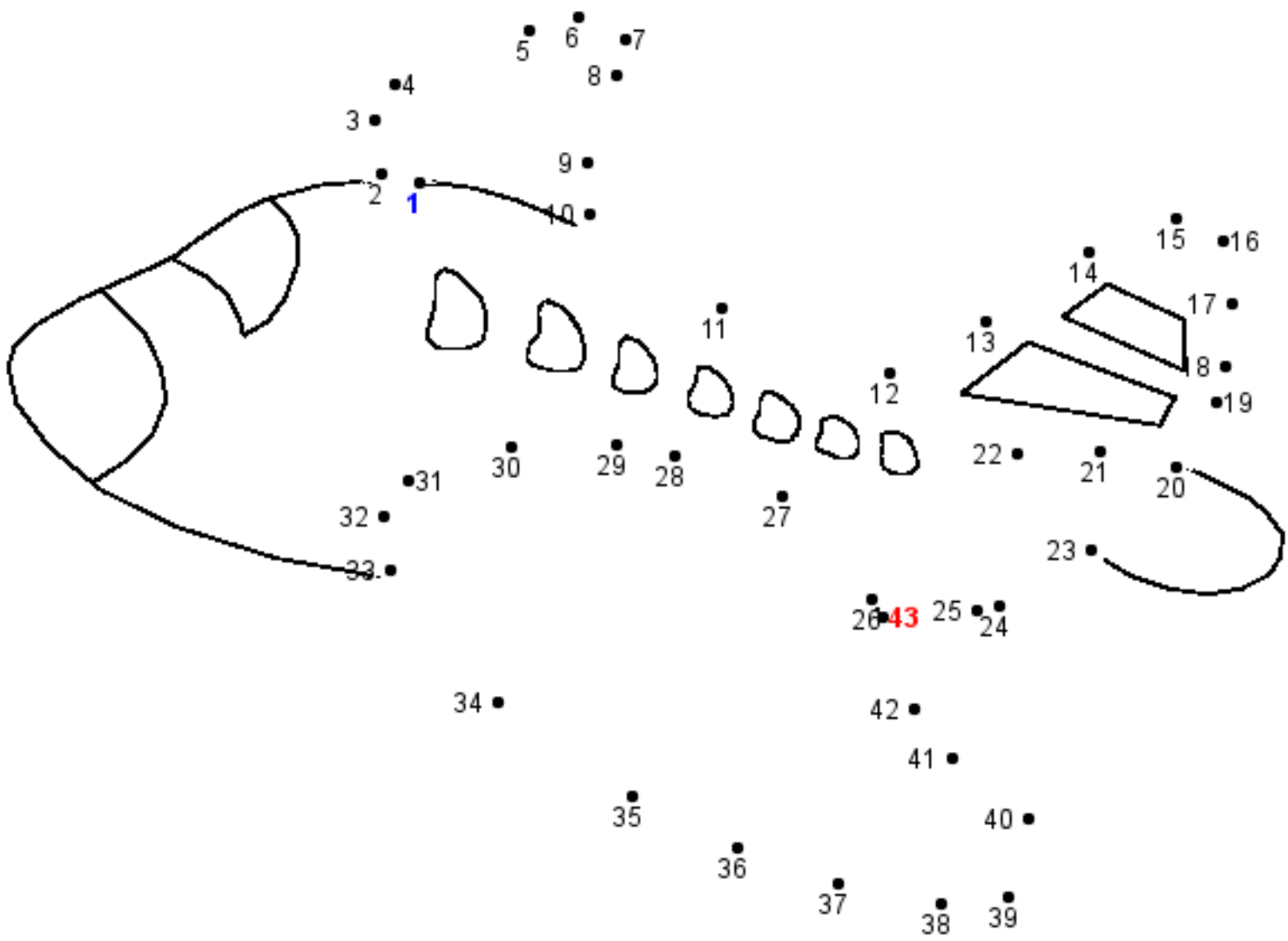



Connect the dots! Count by 1's.

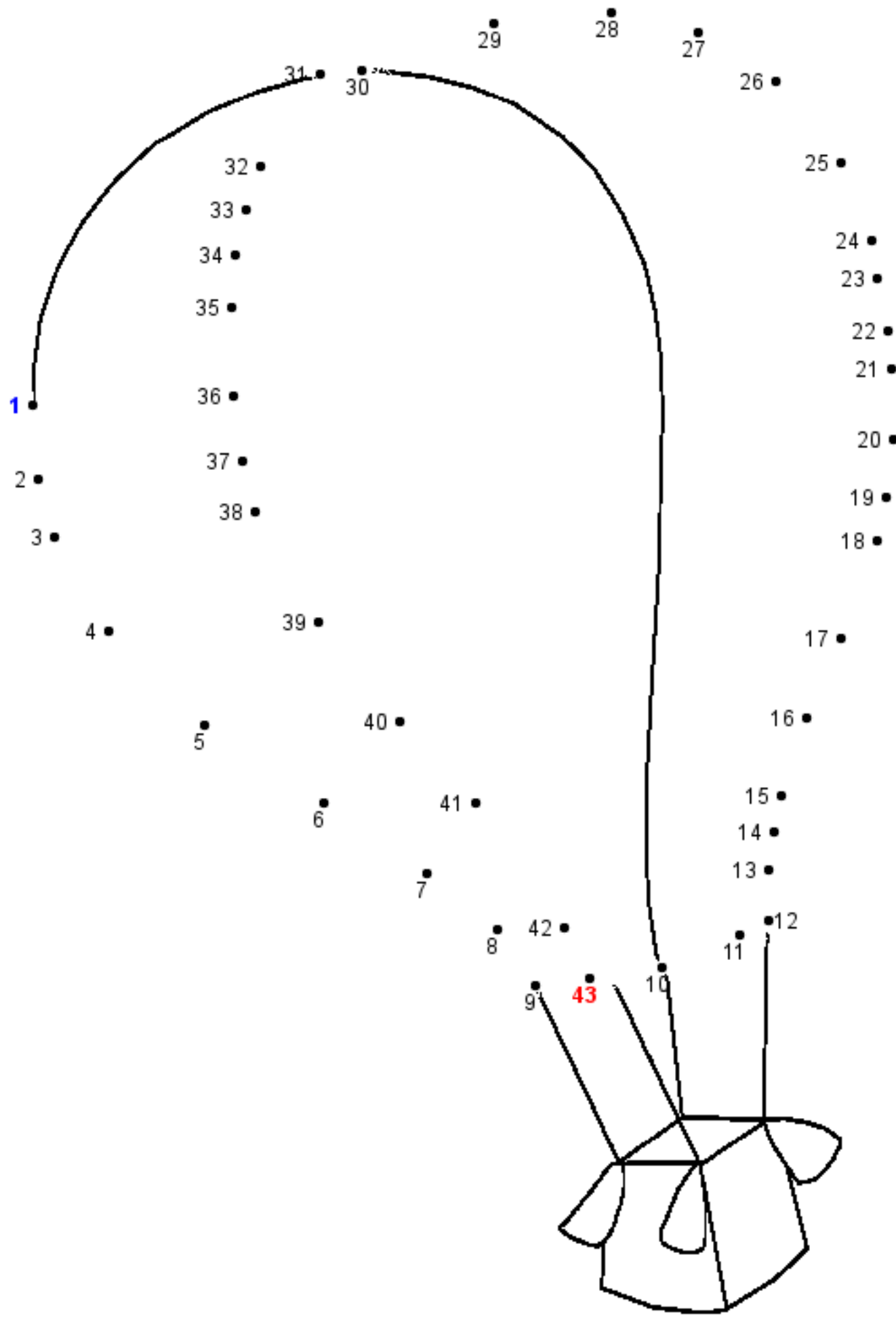

Connect the dots! Count by 1's.



40

39

41

38

37

42

36

35

43

34

33

44

32

45

31

46

30

47

29

48

28

49

27

50

26

25

57

56

55

54

53

52

51

58

24

19

20

21

22

23

18

17

16

1

15

14

13

12

11

10

9

2

3

4

5

6

7

8

Connect the dots! Count by 1's.





Connect the dots! Count by 1's.

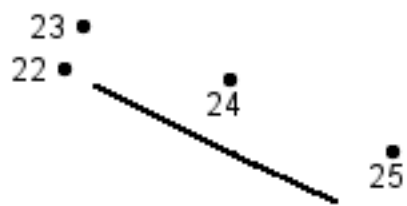

21 •

20 •

19 •

18 •

17 •

16 •

15 •

14 •

13 •

12 •

11 •

10 •

9 •

8 •

7 •

6 •

5 •

4 •

3 •

26 •

27 •

28 •

31 •

32 •

33 •

34 •

35 •

36 •

37 •

38 •

39 •

40 •

47 •

46 •

45 •

44 •

43 •

42 •

41 •

2 •

1 •

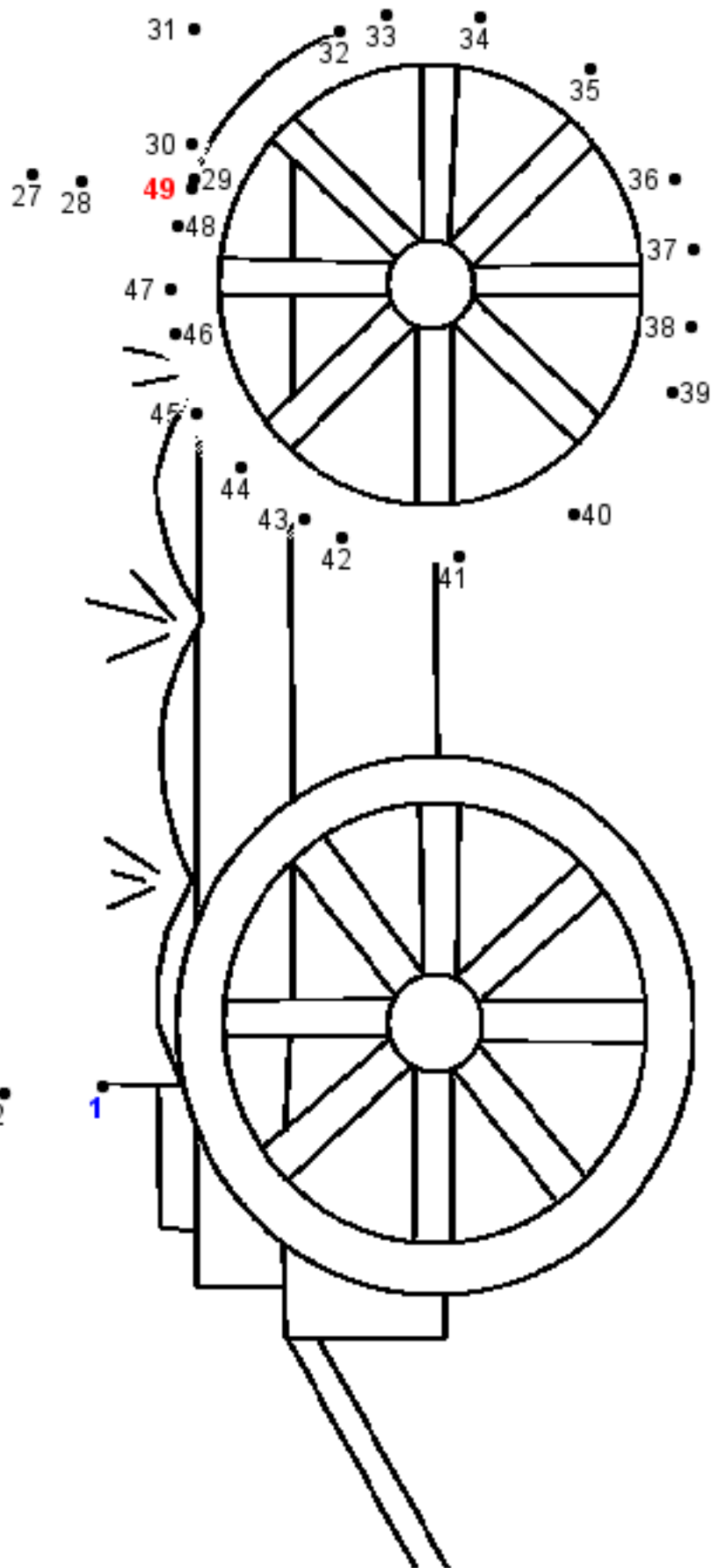

Connect the dots! Count by 1's.

